

THINK and **LOOK** ahead

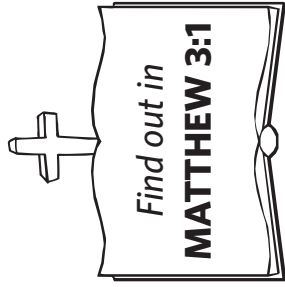

Where did John the Baptist preach his message?

13 5 3

15 6 8 2 3 11 9 3 12 12

10 4 7 14 2 1 3 1

Use the code cracker to check your answer

A	D	E	F	H	I	J	L	N	O	R	S	T	U	W
1	2	3	4	5	6	7	8	9	10	11	12	13	14	15

Be ready!

MATTHEW 24:37-44

Noah listened to God and was ready when the flood came. *What happened to the people who were not ready?*

▲✓ ○✓ ▲☆ □☆ ○◆ ○☆ ○☆ □✚ ○▶ ▲◆ ○✚ ▲☆

▲◆ □◆ □✚ □✓ ▲✚ ▲☆ □▶ ▲✓ ▲✓ ○✓ ▲☆ ○✚

▲◆ ○◆ ○◆ ▲◆ ▲◆ ▲◆ ▲◆



Use the code cracker to find the answer

▲	A	T	W	E	Y
○	L	H	M	O	C
□	N	S	D	F	P
	◆	✓	✚	☆	▶

Only God knows when
Jesus will return!



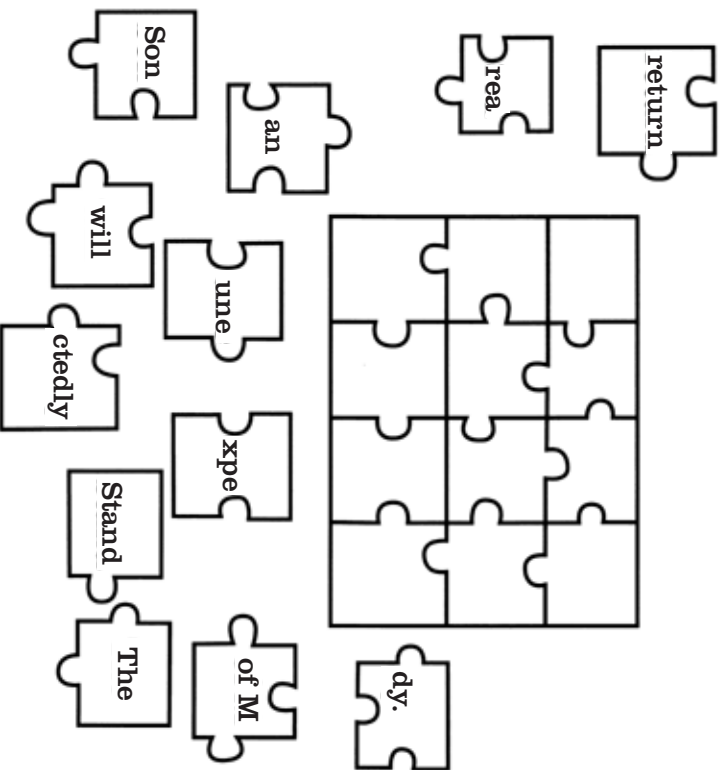





Fit these jigsaw pieces together to read the
advice Jesus gives us in Matthew 24:44



Today is the
First Sunday of Advent.
What does the word
"Advent" mean?



Write the letter that is missing from the second word in the box

In <u>C</u>ARROT		but not <u>P</u>ARROT		<input type="text"/>
In <u>O</u>YHER		but not <u>T</u>HERE		<input type="text"/>
In <u>M</u>AN		but not <u>P</u>AN		<input type="text"/>
In <u>P</u>IE		but not <u>P</u>EN		<input type="text"/>
In <u>N</u>ICE		but not <u>M</u>ICE		<input type="text"/>
In <u>G</u>OAL		but not <u>L</u>OAF		<input type="text"/>

THINK and **LOOK** ahead

• FOOTPRINTS IN FAITH •

SECOND SUNDAY OF ADVENT, YEAR A

John the Baptist

MATTHEW 3:1-12

John could not go to see Jesus himself.
Why not?



Unscramble the words below and
 check your answer in Matthew 11:2

EESUABC

EH

ASW

NI

ONSIPR

John appeared in the wilderness
 and preached to the people.

S	P	A	I	M	L	H	E
R	P	K	N	O	F	A	V
E	E	G	D	S	R	E	A
F	N	H	B	I	N	E	N
O	T	T	S	C	S	M	B
D	R	E	G	L	O	F	L

Follow the arrows
 to find his words

R

→ ↘ ↑ ↙ ↘ ↓ ↖ ↑ ↗ ↘

↗ ↖ ↓ ↘ ↗ ↗ ↘ ↘ ↘ ↘ ↘

↗ → ↘ ↘ ↘ ↘ ↘ ↘ ↘ ↘ ↘

← ↘ → ↘ → ↘ → ↘ → ↘ ↘

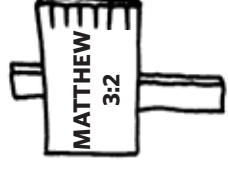

John called the people to say sorry
for turning away from God
and to change their hearts.



Use the code to read the warning he gave them

Z Y X W V U T S R Q P O N M L K J I H G F E D C B A
A B C D E F G H I J K L M N O P Q R S T U V W X Y Z

z m b g i v v g s z g

w l v h m i g y v z i

t l l w u i f r g

d r o o y v x f g

w l d m

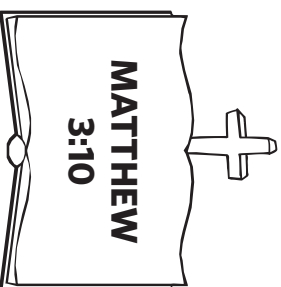

John knew that the time had come
to "prepare a way for the Lord."
We must be prepared too!

How much do you know about time? Try this quiz!

How many seconds in a minute?

How many hours in a day?

How many days in a year?

How many minutes in an hour?

How many weeks in a year?

How many minutes in a day?

